







A01/ XL2000 Operation Manual

Features

- 70 Alpha numeric Canned Messages
- 16 Memory Slots
- Back-light Display
- Slide Switch Select Beep or Vibration
- Date and Time Display
- Message Time stamping
- Message Lock
- Erase Message
- Memory Retention
- Lithium Battery Backup
- Reminder Alert
- Low Battery Indicator
- Duplicate Message

LCD Display

	Beep Mode
	Lock Message
	Clear All Message
ABCD	A,B,C,D, Tone.
	Duplicate Message
	Low Battery Indicator
	Out Of Service
	Next Page

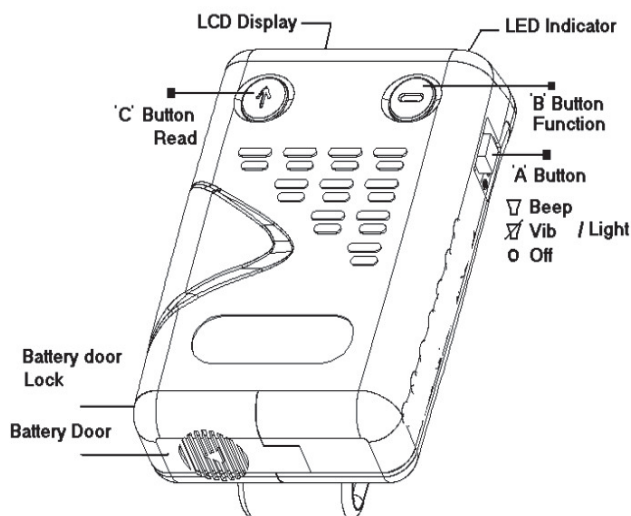

CLEARING ALL MESSAGES

1. Push the "B" button to show "CLEAR ALL?" And "☞" on your LCD.
 2. Push the "C" button to clear all message that you have read and unlock. This will not clear any unread and locked messages.
 3. Push the "A" button to return to stand by and not clear the messages.
- **If there is no message in your pager then "CLEAR ALL?" would not show on the LCD.

LOCKING MESSAGE

When you are reading messages, push "B" button and the "🔒" will be appear on the screen to lock the message.

HOLD DOWN FULLY

When you lock over 8 messages, "HOLD FULL" will display on LCD.

OPERATING YOUR PAGER

POWER ON

Slide the "A" button to "☞" or "▽" to turn on the pager. Slide the "A" button to "O" to turn off the pager. When you turn off the pager, the pager will not receive any messages, but the time and date clock will keep running.

SELECT "VIBRATION" OR "BEEP" MODE

Slide the "A" button to select alert mode. "☞" is set in vibration mode; "▽" is set in beep mode

TURN ON THE BACK-LIGHT FOR LCD

Push in the "A" button to turn on the back-light. If you want to turn off the back-light, push the "A" button again or wait 8 second for the automatic turn off.

READING MESSAGES?

When a message is received, the LED will flash and alert by beep or vibration. You will see "1 PAGE" on your LCD. It means you have one message that has not been read. If "2 PAGES" shows, it means there are two unread messages etc..

You push the "C" button to read the messages.

PAGE OVER

The LCD will show "Page Over" when there are over 16 unread messages. If you do not read the messages and/or delete them then the LCD will read "page over" indicating that you have too many unread messages.

MEMORY FULL

The LCD will show MEMORY FULL when the pager has 16 read or unread messages total in memory.

SETTING TIME & DATE

1. Push the "B" button to show "SET TIME?" on the LCD.
2. Push the "C" button to set the time mode.
3. Push the "C" button to change the number, push the "B" button to move the cursor. When the cursor moves to the end, push the "A" button to save your setting.

INVERTING DIGITS ON LCD

1. Push the "B" button to show "SET INVERT?" On the LCD.
2. Push the "C" button to invert the digits.

DUPLICATE MESSAGE,

The pager recognizes a duplicate message and will not store duplicate messages into memory. " " will show on the LCD.

MESSAGE ERROR

When the pager receives a message error. You will see an "E" on the screen..

UNLOCK MESSAGE

When you are reading messages, you will see the " " on the screen, push the "B" button to unlock the message then the " " will disappear.

OUT OF SERVICE

When you are out of the service area, the " " will show on LCD.

LOW BATTERY

When the battery voltage drops, the " " will show on the screen to notify you that battery replacement is necessary.

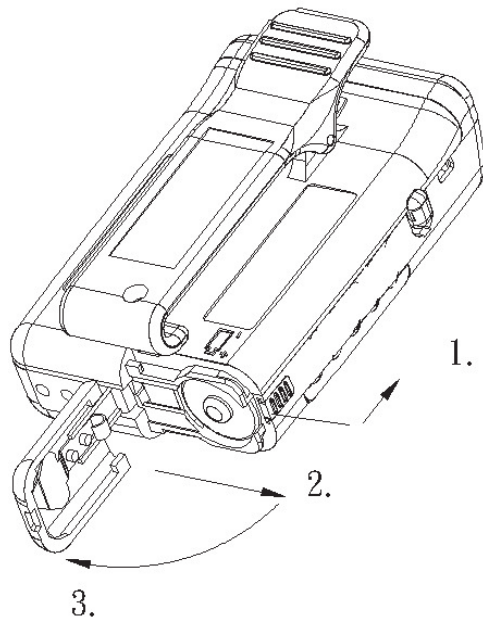

BATTERY INSTALLATION

1. Before removing or inserting the battery, be sure the POWER SWITCH is off
2. Slide the battery cover lock in the direction of arrow 1, slide the battery cover in the direction of arrow 2 and then open in the direction of arrow 3.
3. Remove the old AA battery from the compartment.
4. Insert the new AA battery from its (-) side. Attach the battery cover and slide the battery cover lock to the LOCK Position.

WARNING: Do not dispose of used battery in fire; explosion may occur.

70 ALPHA NUMERIC CANNED MESSAGES

0	C-U-LATER	20	MALL	40	CALL MY CELL	60	I AM SORRY
1	TURN ON CELL	21	PLAY B-BALL	41	NO HURRY	61	STOP CALLING
2	HAPPY B-DAY	22	PLAY Q-BALL	42	CALL OFFICE	62	RUNNING LATE
3	COME HOME	23	PLAY CARDS	43	LETS PLAY	63	PIC ME UP
4	CALL HOME	24	GO BOWLING	44	BEEP ME	64	SEE YOU SOON
5	DO NOT 4-GET	25	GO CRUISING	45	NEED 2 MEET	65	COME BAC
6	GOOD NIGHT	26	GO SHOPPING	46	CALL ME	66	I AM HOME
7	HELLO	27	GO SWIMMING	47	TIME 4 LOVE	67	MEET YOU AT
8	HOW ARE YOU ?	28	HAVE LUNCH ?	48	CHANGE TIME	68	DELAY TIL
9	I LOVE YOU	29	HAVE DINNER ?	49	WANT 2 SEE U	69	URGENT
10	I NEED YOU	30	WANNA GO EAT	50	SMILE 4 ME	70	PLS PAY BILL
11	I MISS YOU	31	WANNA HANG ?	51	ON TIME		
12	NEED HELP	32	YES	52	DELAY		
13	NEED INFO	33	NO	53	CANCEL		
14	HURRY UP	34	MAY BE	54	APPOINTMENT		
15	WAITING 4-U	35	CLUBBING	55	BIRTHDAY		
16	EMERGENCY	36	MEETING	56	BEACH		
17	MEET AT CAF	37	SO COOL	57	VACATION		
18	MOVIES	38	HI ! BABY	58	DANCE		